

<b>TEST REPORT</b> <b>VDE-AR-N 4105:2011 in conjunction with E DIN V VDE V 0124-100:2013</b> <b>Power generation systems connected to the low-voltage distribution network</b>	
Report Reference No. ....	161008074GZU-001
Date of issue .....	01 Nov., 2016
Total number of pages.....	46 Pages
<b>Testing Laboratory</b> .....	Intertek Testing Services Shenzhen Ltd. Guangzhou Branch
Address.....	Block E, No.7-2 Guang Dong Software Science Park, Caipin Road, Guangzhou Science City, GETDD, Guangzhou, China
Testing location/ address.....	Same as above
Tested by (name + signature) .....	Jason Fu 
Approved by (+ signature).....	Tommy Zhong 
<b>Applicant's name</b> .....	Shenzhen SOFARSOLAR Co., Ltd.
Address.....	5L, Fourth Building, Antongda Industrial Park, Liuxian Avenue No.1, Xinan Street, Baoan District, Shenzhen, China.
<b>Test specification:</b>	
Standard .....	VDE-AR-N 4105:2011 in conjunction with E DIN V VDE V 0124-100:2013-10
Test procedure.....	Type test
Non-standard test method.....	N/A
<b>Test Report Form No.</b> .....	VDE-AR-N 4105b
Test Report Form(s) Originator .....	Intertek Taiwan
Master TRF.....	Dated 2013-10
This publication may be reproduced in whole or in part for non-commercial purposes as long as Intertek is acknowledged as copyright owner and source of the material. Intertek takes no responsibility for and will not assume liability for damages resulting from the reader's interpretation of the reproduced material due to its placement and context.	
<b>Test item description</b> .....	AC-coupled Storage Converter
Trade Mark .....	
Manufacturer.....	Same as Applicant
Model/Type reference .....	ME 3000SP

Rating.....:	Battery Type: Lead-acid, Lithium-ion Battery Voltage Range: 42-58Vdc Max. Charging Current: 60A Max. Discharging Current: 60A Max. Charging & Discharging Power: 3000VA Nominal Grid Voltage: 230Vac Nominal output Voltage (stand-alone): 230Vac Max. output Current: 13A Nominal Grid frequency: 50Hz Power factor: 1 (adjustable +/-0.8) Ingress protection: IP65 Operating Temperature Range: -25°C - 60°C Protective Class: Class I
--------------	--

Summary of testing:																																	
<b>Tests performed (name of test and test clause):</b>	<b>Testing location:</b>																																
<table border="1"> <thead> <tr> <th>VDE4105 (VDE0124)</th> <th>Test Description</th> </tr> </thead> <tbody> <tr> <td>5.4.2 (5.1.2)</td> <td>Rapid voltage change</td> </tr> <tr> <td>5.4.3 (5.1.3)</td> <td>Flicker</td> </tr> <tr> <td>5.4.4 (5.1.4)</td> <td>Harmonics and inter-harmonics</td> </tr> <tr> <td>5.5 &amp; 5.6 (5.2)</td> <td>Symmetry Behavior of Three-Phase Inverter Units</td> </tr> <tr> <td>5.7.3.2 (5.3.3)</td> <td>Generation management/network security management</td> </tr> <tr> <td>5.7.3.3 (5.3.4)</td> <td>Active power feed-in at overfrequency</td> </tr> <tr> <td>5.7.3.4 (5.3.5)</td> <td>Active power feed-in at underfrequency</td> </tr> <tr> <td>5.7.5 (5.3.2 &amp; 5.3.6)</td> <td>Measurement of reactive and active power range</td> </tr> <tr> <td>6.3 (5.4.3)</td> <td>Integrated NS protection</td> </tr> <tr> <td>6.4 (5.4.4.1 &amp; 5.4.4.2)</td> <td>Interface switch</td> </tr> <tr> <td>6.5.1 (5.4.5.1 &amp; 5.4.5.2)</td> <td>Protective arrangements for the Interface switch</td> </tr> <tr> <td>6.5.2 (5.4.5.3 &amp; 5.4.5.5)</td> <td>Protective functions</td> </tr> <tr> <td>6.5.3 (5.4.6.1 &amp; 5.4.6.2)</td> <td>Islanding detection</td> </tr> <tr> <td>8.3.1 (5.4.7.1 &amp; 5.4.7.2)</td> <td>Connection conditions and synchronisation</td> </tr> <tr> <td>8.3.4</td> <td>Connection of power generation units with inverters</td> </tr> </tbody> </table>	VDE4105 (VDE0124)	Test Description	5.4.2 (5.1.2)	Rapid voltage change	5.4.3 (5.1.3)	Flicker	5.4.4 (5.1.4)	Harmonics and inter-harmonics	5.5 & 5.6 (5.2)	Symmetry Behavior of Three-Phase Inverter Units	5.7.3.2 (5.3.3)	Generation management/network security management	5.7.3.3 (5.3.4)	Active power feed-in at overfrequency	5.7.3.4 (5.3.5)	Active power feed-in at underfrequency	5.7.5 (5.3.2 & 5.3.6)	Measurement of reactive and active power range	6.3 (5.4.3)	Integrated NS protection	6.4 (5.4.4.1 & 5.4.4.2)	Interface switch	6.5.1 (5.4.5.1 & 5.4.5.2)	Protective arrangements for the Interface switch	6.5.2 (5.4.5.3 & 5.4.5.5)	Protective functions	6.5.3 (5.4.6.1 & 5.4.6.2)	Islanding detection	8.3.1 (5.4.7.1 & 5.4.7.2)	Connection conditions and synchronisation	8.3.4	Connection of power generation units with inverters	<p>Intertek Testing Services Shenzhen Ltd. Guangzhou Branch</p> <p>Block E, No.7-2 Guang Dong Software Science Park, Caipin Road, Guangzhou Science City, GETDD, Guangzhou, China</p>
VDE4105 (VDE0124)	Test Description																																
5.4.2 (5.1.2)	Rapid voltage change																																
5.4.3 (5.1.3)	Flicker																																
5.4.4 (5.1.4)	Harmonics and inter-harmonics																																
5.5 & 5.6 (5.2)	Symmetry Behavior of Three-Phase Inverter Units																																
5.7.3.2 (5.3.3)	Generation management/network security management																																
5.7.3.3 (5.3.4)	Active power feed-in at overfrequency																																
5.7.3.4 (5.3.5)	Active power feed-in at underfrequency																																
5.7.5 (5.3.2 & 5.3.6)	Measurement of reactive and active power range																																
6.3 (5.4.3)	Integrated NS protection																																
6.4 (5.4.4.1 & 5.4.4.2)	Interface switch																																
6.5.1 (5.4.5.1 & 5.4.5.2)	Protective arrangements for the Interface switch																																
6.5.2 (5.4.5.3 & 5.4.5.5)	Protective functions																																
6.5.3 (5.4.6.1 & 5.4.6.2)	Islanding detection																																
8.3.1 (5.4.7.1 & 5.4.7.2)	Connection conditions and synchronisation																																
8.3.4	Connection of power generation units with inverters																																

**Copy of representative marking plate (representative):**

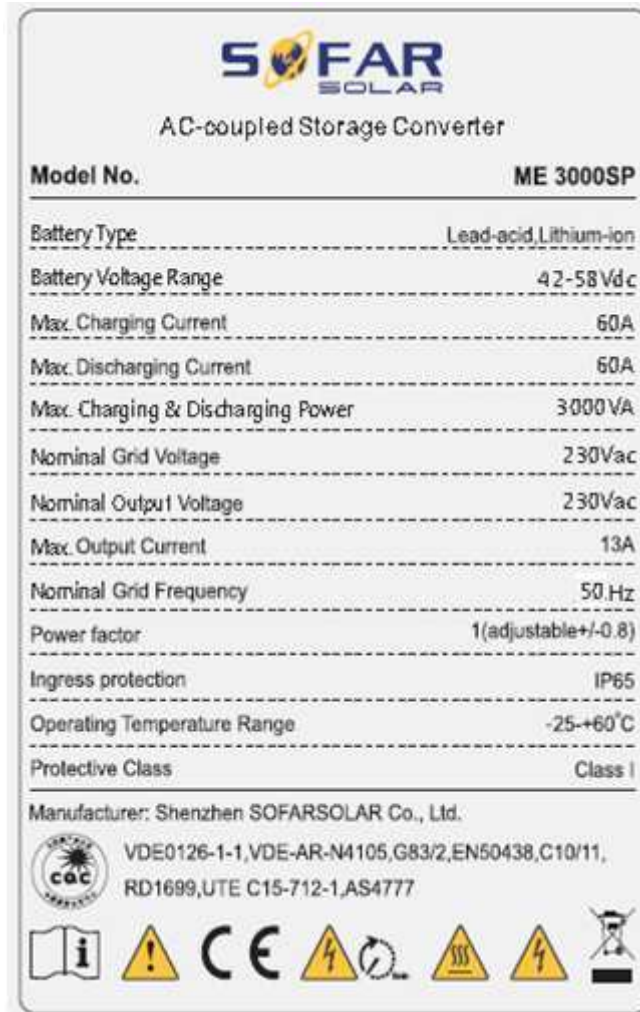

**Note:**

1. The above markings are the minimum requirements required by the safety standard. For the final production samples, the additional markings which do not give rise to misunderstanding may be added.
2. Label is attached on the side surface of enclosure and visible after installation

<b>Test item particulars</b> .....	
Temperature range .....	-25°C ~ +60 °C
AC Overvoltage category .....	<input type="checkbox"/> OVC I <input type="checkbox"/> OVC II <input checked="" type="checkbox"/> OVC III <input type="checkbox"/> OVC IV
DC Overvoltage category .....	<input type="checkbox"/> OVC I <input checked="" type="checkbox"/> OVC II <input type="checkbox"/> OVC III <input type="checkbox"/> OVC IV
IP protection class .....	IP65
<b>Possible test case verdicts:</b>	
- test case does not apply to the test object .....	: N/A (Not applicable)
- test object does meet the requirement.....	: P (Pass)
- test object does not meet the requirement.....	: F (Fail)
<b>Testing</b> .....	
Date of receipt of test item .....	: 08 Oct., 2016
Date (s) of performance of tests .....	: 08 Oct., 2016 – 29 Oct., 2016
<b>General remarks:</b>	
<p>The test results presented in this report relate only to the object tested.          This report shall not be reproduced, except in full, without the written approval of the Issuing testing laboratory.          "(see Enclosure #)" refers to additional information appended to the report.          "(see appended table)" refers to a table appended to the report.</p> <p>When determining for test conclusion, measurement uncertainty of tests has been considered.          This report is for the exclusive use of Intertek's Client and is provided pursuant to the agreement between Intertek and its Client. Intertek's responsibility and liability are limited to the terms and conditions of the agreement. Intertek assumes no liability to any party, other than to the Client in accordance with the agreement, for any loss, expense or damage occasioned by the use of this report. Only the Client is authorized to permit copying or distribution of this report and then only in its entirety. Any use of the Intertek name or one of its marks for the sale or advertisement of the tested material, product or service must first be approved in writing by Intertek. The observations and test results in this report are relevant only to the sample tested. This report by itself does not imply that the material, product, or service is or has ever been under an Intertek certification program.          The test report only allows to be revised only within the report defined retention period unless standard or regulation was withdrawn or invalid.</p> <p>Throughout this report a point is used as the decimal separator.</p>	

**General product information:**

The equipment under test is single phase energy storage inverter. They are responsible for converting the direct current generated by battery into single-phase 230V, 50 Hz. It is basic insulation between grid and battery. Two mechanical disconnection device (relay) is provided between grid and battery on line and neutral conductor

The equipments have three working mode. Charge mode, Discharge mode, Stand-alone mode :

Charge mode: The AC voltage from mains charges the battery provided in the final system.

Discharge mode: The inverter converts the energy from the battery to 230Va.c.,50 Hz voltage and connected to AC mains. In this mode the inverter works as grid connected inverter.

Stand-alone mode: The inverter converter the energy from the battery to 230Va.c.,50 Hz voltage and feed the general load. In this mode the inverter worked as stand-alone inverter.

**Factory information:**

Shenzhen SOFARSOLAR Co., Ltd.

5L,Fourth Building,Antongda Industrial Park,Liuxian Avenue No.1,Xinan Street,Baoan District,Shenzhen,China.

VDE-AR-N 4105:2011 in conjunction with E DIN V VDE V 0124-100:2013			
Clause	Requirement - Test	Result - Remark	Verdict
<b>4</b>	<b>General framework conditions</b>		N/A
4.1	<b>Provisions and regulations</b>	This report is only evaluated and tested for PGU; the PGS incorporated with the PGU shall further consider this clause and sub-clause.	N/A
4.2	<b>Application procedure and connection relevant document</b>	Shall consider in final PGS	N/A
4.3	<b>Initial start-up of the power generation system</b>	Shall consider in final PGS	N/A
<b>5</b>	<b>Network connection</b>		<b>P</b>
5.1	<p><b>Principles for determination of the network connection point</b></p> <p>Power generation systems shall be connected at a suitable point in the network, the network operator determines the suitable network connection point that ensures safe network operation, also when taking account of the power generation system, and at which the power applied for can be drawn and transmitted. The decisive aspect for evaluation of the network connection is always the behaviour of the power generation system at the network connection point or at the PCC. This is to ensure that the power generation system is operated without interfering reactions and without affecting the supply of other customers. Annex E shows examples for connection evaluations of power generation systems.</p> <p>Power generation systems which are installed on different plots with their own respective network connections shall, as a rule, not be connected to the network operator's network together in the same network connection point. Power generation systems installed on a building with several network connections may be connected to the network operator's network together at the same network connection point.</p> <p>All separate supply points shall be permanently marked by the supply point owner with the following label "Sectioning point" power generation system/ supply network".</p>	Shall consider in final PGS	N/A

VDE-AR-N 4105:2011 in conjunction with E DIN V VDE V 0124-100:2013			
Clause	Requirement - Test	Result - Remark	Verdict
5.2	<p><b>Rating of the network equipment</b></p> <p>Power generation systems may cause higher loading of lines, transformers and other network equipment. Therefore, the network operator examines the loading capacity of the network equipment with regard to the connected power generation systems in accordance with the relevant rating regulations. For calculation purposes the maximum apparent power of the sum of all power generation systems <math>S_{Amax}</math> and usually the load factor <math>m=1</math> shall be used. The only exceptions are buried cables for the connection of photovoltaic systems for which a load factor <math>m= 0.7</math> shall be used.</p>	Shall consider in final PGS	N/A
5.3	<p>Permissible voltage change</p> <p>For undisturbed operation of the network, the amount of the voltage change caused by all power generation systems with a network connection point in a low-voltage network shall at none of the PCCs in this network may a value of 3 % as compared with the voltage without power generation systems. If stipulated by the network operator and if necessary, taking into account the possibilities of the static voltage stability it may be permitted in individual justified cases to deviate from this value of 3%. When calculating the voltage change, the displacement factor shall be taken into account which is provided by the network operator for the maximum apparent connection power of the power generation system <math>S_{Amax}</math>. For determination of the voltage change for meshed low-voltage networks an high spatially distributed feed-in powers, it is recommended to use complex load-flow calculations.</p>	Shall consider in final PGS	N/A
5.4	<p><b>System reactions</b></p>		<b>P</b>
5.4.1	<p><b>General</b></p> <p>The electrical installations of the customer system shall be planned, constructed and operated so that reactions to the network operator's network and to the systems of other customers are permanently reduced to a permissible minimum. Should interfering reactions on the network operator's network occur nonetheless, the customer shall apply measured to his system that is to be coordinated with the network operator. The network operator is entitled to disconnect the power generation system concerned from the network until the deficiencies are corrected. The connection owner provides the network operator with values from the device documents of the manufacturer which are necessary in order to evaluate system reactions (see Annex F.3).</p>		<b>P</b>



VDE-AR-N 4105:2011 in conjunction with E DIN V VDE V 0124-100:2013			
Clause	Requirement - Test	Result - Remark	Verdict
5.4.2	<p><b>Rapid voltage changes</b></p> <p>Voltage changes at the PCC attributable to the simultaneous connection and disconnection of power generation units do not give rise to inadmissible network reactions if the maximum voltage change does not exceed a value of 3% (related to <math>U_n</math>) at the PCC.</p> <p>For a value of 3% the frequency shall not exceed once every 10 min.</p> <p>Depending on the network short-circuit power <math>S_{KV}</math> at the PCC of maximum apparent connection power <math>S_{E_{max}}</math> of the activated power generation unit and on the ratio of starting current <math>I_a</math> to rated current <math>I_{rE}</math>, the voltage change can be estimated.</p>	<p>Kimax is measured to comply with Cl.8.3.4</p> <p>The final installation of PGS shall be calculated</p>	P
5.4.3	<p><b>Flicker</b></p> <p>The measured variable and the evaluation criterion for flicker caused by power generation systems is the long-term flicker strength <math>P_{lt}</math>.</p> <p>For power generation systems with rated currents of up to 75 A, reactions are deemed to be limited sufficiently, if the power generation units comply with the limit values given in DIN EN 61000-3-3 (VDE 0838-3) or DIN EN 61000-3-11 (VDE 0838-11), respectively.</p> <p>Together, all power generation systems in the low-voltage network shall not exceed the following flicker strength at the most unfavourable PCC:</p> <p>Long-term flicker strength: <math>P_{lt} = 0.5</math>.</p> <p>This value also applies to power generation systems with rated currents above 75A.</p>	<p>The limited value for PGS shall be considered in final installation</p> <p>The <math>P_{lt}</math> is calculated for PGS final installation</p>	P

VDE-AR-N 4105:2011 in conjunction with E DIN V VDE V 0124-100:2013			
Clause	Requirement - Test	Result - Remark	Verdict
5.4.4	<p><b>Harmonics and inter-harmonics</b></p> <p>The currents of harmonics and inter-harmonics generated by power generation systems shall be included in the conformity check.</p> <p>For power generation systems reactions are deemed to be limited sufficiently, if the power generation units comply with the following limit values:</p> <ul style="list-style-type: none"> <li>- for rated currents of up to and including 16 A per conductor: the limit values of class A (Table 1) specified in DIN EN 61000-3-2 (VDE0838-2);</li> <li>- for rated currents above 16 A and up to and including 75 A per conductor: the limit values of Table 2 and Table 3 specified in DIN EN 61000-3-12 (VDE 0838-12).</li> </ul> <p>If in the standard mentioned, limit values are explicitly stated for power generation units then these limit values shall apply.</p>	<p>Harmonics is measured according to VDE V 0124-100 CL.5.1.4</p> <p>The inverter comply with the limit of DIN EN 61000-3-12</p>	P
5.4.5	<p><b>Voltage unbalance</b></p> <p>If several single-phase power generation systems are connected to the same network connection point, then uniform distribution of the power supplied to the three line conductors shall be aimed for, where a maximum power difference of 4.6kVA shall not exceed.</p>	Single-phase inverter	N/A
5.4.6	<p><b>Commutation notches</b></p> <p>The relative depth of commutation notches <math>d_{kom}</math> through line-commutated inverters shall not exceed the value of <math>d_{kom} = 5 \%</math></p>		N/A

VDE-AR-N 4105:2011 in conjunction with E DIN V VDE V 0124-100:2013			
Clause	Requirement - Test	Result - Remark	Verdict
5.4.7	<p><b>Audio-frequency centralised ripple-control</b></p> <p>Audio-frequency centralised ripple-control are usually operated at frequencies between approx. 100 Hz and 1500 Hz. Information about the locally applied ripple-control frequency can be obtained from the network operator. Broadcasting levels of audio-frequency impulses are normally about 1 % <math>U_n</math> to 4 % <math>U_n</math>.</p> <p>Apart from the limitation of the level reduction, it is not allowed to generate inadmissible interference voltages. The following rules shall apply in particular:</p> <ul style="list-style-type: none"> <li>- The interference voltage caused by a power generation system whose frequency corresponds to the locally applied ripple-control frequency or is very close to it (+/- 5 Hz), shall not exceed the value of 0.1 % <math>U_n</math>.</li> <li>- The interference voltage caused by a power generation system whose frequency lies at the ambient frequencies of +/- 100 Hz to the locally applied ripple-control frequency or in its immediate proximity, shall not exceed a value of 0.3 % <math>U_n</math>.</li> </ul>	Considered for final PGS	N/A
5.4.8	<p><b>Carrier frequency usage of the customer network</b></p> <p>If the system operator runs a system with carrier frequency usage of this network, then shall be ensured by means of suitable devices that interfering influences on other customer systems as well as on the systems of the network operator are avoided.</p> <p>Shared usage of the network operator's network by the customer is permitted solely with the network operator's consent for the carrier frequent transmission of signals.</p>	Considered for final PGS	N/A
5.4.9	<p><b>Precautionary measures against voltage drops and voltage interruptions</b></p> <p>If power generation systems are sensitive to short-time voltage drops or interruptions of supply, then the customer shall take suitable measures to safeguard the system and to ensure operation operational safety.</p>	The PGU integral with NS protection to disconnect from grid	P

VDE-AR-N 4105:2011 in conjunction with E DIN V VDE V 0124-100:2013			
Clause	Requirement - Test	Result - Remark	Verdict
5.5	<p><b>Connection criteria</b></p> <p>For the technical execution of connections of the power generation system or the customer system with a power generation system, the technical connections of the network operator shall be considered. If the generated power is fully supplied to the network operator's network, then the connection line of the power generation system shall be firmly connected to the meter panel within the customer system and the meter panel shall then be executed in accordance with the applicable Technical connection condition.</p> <p>Power generation systems may also be single-phase connected to the network, if the sum of all single-phase connected power generation units per network connection does not exceed the following: <math>S_{E_{max}} \leq 4.6kVA</math> per line conductor. It is possible to connect in single phase, distributed to the three line conductors, at maximum <math>3 \times 4.6kVA = S_{E_{max}} \leq 13.8kVA</math>. The limits given above are exceeded at the network connection point, any extension shall be three-phase connected to the three-phase system. This requirement may also be satisfied by communicatively coupling single-phase connected power generation units of the same primary energy carrier.</p> <p>The communicative coupling between power generation units ensures the power generation system's balanced supply to the individual line conductors of the three-phase network in accordance with three-phase inverter systems.</p> <p>For all that, the maximum permissible imbalance of 4.6kVA at a single network connection point for the sum of all power generation systems applies here as well.</p>		P
5.6	<b>Three-phase network</b>		N/A
5.6.1	<p><b>General</b></p> <p>For the purposes of maintaining the symmetric characteristics of the three-phase network, three-phase power generation systems shall have the characteristics described in the following.</p>		N/A
5.6.2	<p><b>Three-phase synchronous generators</b></p> <p>Synchronous generators generate an electromotive force (EMF) or synchronous generated voltage (open-circuit voltage), respectively, satisfying the conditions for ideal balance.</p>		N/A

VDE-AR-N 4105:2011 in conjunction with E DIN V VDE V 0124-100:2013			
Clause	Requirement - Test	Result - Remark	Verdict
5.6.3	<p><b>Three-phase inverter systems</b></p> <p>For three-phase power generation systems with network feed-in over inverters, the power shall be fed three-phase balanced into the three line conductors. The inverter circuit shall preferably be set up as a three-phase current unit.</p> <p>A circuit of single –phase inverters is deemed to be technically equivalent, if these inverters feed three-phase balanced into the three line conductors by means of a suitable communicative coupling.</p> <p>In the medium term, three-phase inverter systems shall provide all the three-phase related functions of the three-phase synchronous generators.</p>		N/A
5.7	<b>Behaviour of the power generation system at the network</b>		<b>P</b>
5.7.1	<p><b>General</b></p> <p>Automatic disconnection from the network is not permitted for frequency deviations within the range of 47.5 Hz to 51.5 Hz. The mode of action is described in detail in 5.7.3.3 and 5.7.3.4. Implementation of the frequency dependent active load control is carried out in the open-loop control of the power generation units.</p>	The PGU remain operation during the frequency range 47.5Hz to 51.5Hz	P
5.7.2	<p><b>Maximum permissible short-circuit current</b></p> <p>Due to operation of power generation system, the short-circuit current of the low-voltage network is increased by the short-circuit current of the power generation system. Therefore, information about the short-circuit current of the power generation system to be expected at the network connection point has shall be provided in accordance with 4.2. For determination of the short-circuit current contributed by the power generation system the following roughly estimated values can be assumed :</p> <ul style="list-style-type: none"> <li>- For synchronous generators: 8 times the rated current;</li> <li>- For asynchronous generators: 6 times the rated current;</li> <li>- For generators with inverters: 1 time the rated current.</li> </ul>	Considered in final PGS	N/A

VDE-AR-N 4105:2011 in conjunction with E DIN V VDE V 0124-100:2013			
Clause	Requirement - Test	Result - Remark	Verdict
5.7.3	<b>Active power output</b>		<b>P</b>
5.7.3.1	<b>Basics</b>		P
5.7.3.2	<p><b>Generation management/network security management</b></p> <p>Power generation systems with a system power of more than 100 kW shall be able to reduce their active power in steps of not more than 10 % of the maximum active power <math>P_{Amax}</math>. For every operational state and from each and every operation point, it shall be possible for this power to be reduced to a set point provided by the network operator. This set point is generally provided at the network connection point gradually or continually and it corresponds to a percentage related to the maximum active power <math>P_{Amax}</math>.</p> <p>Variable power generation systems shall carry out the power output reduction to the respective set point immediately, however, at maximum within a minute. It shall be technically possible for these power generation systems to reduce the power to the set point 10% without automatic disconnection from the network, and only at a value o less than 10% of the maximum active power <math>P_{Amax}</math> is they permitted to disconnect the network.</p> <p>All other power generation systems shall carry out the power output reduction to the respective set point within a maximum period of five minutes. If the set point is not reached within five minutes, then the power generation system shall be disconnected.</p>	<p>The PGU is able to reduce active output power via RS485 interface. The final PGS installation shall be equipped with an interface device between the dry contact of network operator.</p> <p>Although the power of PGU is less than 100KW. However, it can fulfil the requirement of EEG</p> <p>The communication port of PGU is RS 485. it should be adapted with external contact signals for final PGS installation</p>	P

VDE-AR-N 4105:2011 in conjunction with E DIN V VDE V 0124-100:2013			
Clause	Requirement - Test	Result - Remark	Verdict
5.7.3.3	<p><b>Active power feed-in at overfrequency</b></p> <p>At frequencies between 50.2 Hz and 51.5 Hz, all adjustable power generation systems shall reduce or increase the active power <math>P_M</math> generated instantaneously with a gradient of 40 % of <math>P_M</math> per Hz. It follows that the power generation unit will continuously move up and down the frequency characteristic curve in the frequency range of 50.2 Hz to 51.5 Hz with regard to its active power feed-in. the increment of the frequency measurement shall be <math>\leq 10</math> mHz.</p> <p>If the mains frequency drops again to a value below 50.2 Hz and if the possible generation power is greater at that instant than the active power <math>P_M</math>, then the increase of the active power supplied to the network operator's network shall not exceed a gradient of 10 % of the maximum active power <math>P_{Amax}</math> per minute.</p> <p>At mains frequencies <math>&gt; 51.5</math> Hz, the power generation system shall disconnect from the network immediately.</p> <p>There are no restrictions for frequencies of <math>47.5 \text{ Hz} \leq f_{mains} \leq 50.2 \text{ Hz}</math>.</p> <p>Disconnection from the network is required for <math>f_{mains} \leq 47.5 \text{ Hz}</math> and <math>f_{mains} \geq 51.5 \text{ Hz}</math>.</p>	(See appended table)	P
5.7.3.4	<p><b>Active power feed-in at underfrequency</b></p> <p>For frequencies between 47.5 Hz and 50.0 Hz, automatic disconnection from the network as a result of a frequency deviation is not permitted.</p>	PGU normally operate.	P
5.7.4	<p><b>Principles for network support</b></p> <p>Power generation systems shall be able to contribute to the static voltage stability in the network operator's network. Static voltage stability is understood to be the voltage stability in the low-voltage network at which the slow voltage changes are maintained within compatible limits in the distribution network.</p>	Considered in final PGS	N/A

VDE-AR-N 4105:2011 in conjunction with E DIN V VDE V 0124-100:2013			
Clause	Requirement - Test	Result - Remark	Verdict
5.7.5	<p><b>Reactive power</b></p> <p>Irrespective of the number of feed-in phases, power generation systems shall allow for operation under normal stationary operating conditions in the voltage tolerance band <math>U_n \pm 10\%</math> and in their permissible operation points starting with an active power of more than 20 % of the rated active power with the following displacement factors <math>\cos\phi</math>:</p> <ul style="list-style-type: none"> <li>- power generation system <math>S_{E_{max}} \leq 3.68 \text{ kVA}</math>: <math>\cos\phi = 0.95</math> under-excited to <math>0.95</math> over-excited.</li> <li>- power generation system <math>3.68 \text{ kVA} &lt; S_{E_{max}} \leq 13.8 \text{ kVA}</math>: characteristic curve provided by the network operator within <math>\cos\phi = 0.95</math> under-excited to <math>0.95</math> over-excited</li> <li>- power generation system <math>S_{E_{max}} &gt; 13.8 \text{ kVA}</math>: characteristic curve provided by the network operator within <math>\cos\phi = 0.90</math> under-excited to <math>0.90</math> over-excited.</li> </ul>	<p>PGU <math>S_{E_{max}} &lt; 3.68\text{kVA}</math>: characteristic curve provided by the network operator within <math>\cos\phi = 0.95</math> under-excited to <math>0.95</math> over-excited.</p> <p>( See appended table )</p>	P
<b>6</b>	<b>Construction of the power generation system/network and system protection (NS protection)</b>		P
6.1	<p><b>General requirements</b></p> <p>The network and system protection (NS protection) is a type-tested protective device with a conformity certificate in which all protective functions specified in 6.5 are installed. The NS protection acts on the interfaces switch in accordance with 6.4. The NS protection shall be realized as central NS protection at the central meter panel. For power generation systems of <math>\leq 30\text{kVA}</math> it is also permitted to have an NS protection installed in the power generation unit(s). depending on the sum of the maximum apparent powers of all power generation systems connected to the same network connection point, <math>S_{A_{max}}</math>. The following conditions apply for the NS protection:</p> <ul style="list-style-type: none"> <li>- <math>S_{A_{max}} &gt; 30\text{kVA}</math>: Central NS protection at the central meter panel.</li> <li>- <math>S_{A_{max}} \leq 30\text{kVA}</math>: Central NS protection at the central meter panel or decentralized in a sub-distribution or integrated NS protection</li> </ul> <p>The loss of the auxiliary voltage of the central NS protection or the control of the integrated NS protection shall lead to an instantaneous tripping of the interface switch. Tripping of a relay of the integrated protection disconnection periods is kept. The protective functions shall be maintained even in the event of a malfunction in the system control.</p> <p>Single-fault tolerance shall be ensured for both central and integrated NS protection.</p>	<p>Integrated NS protection</p> <p>For final PGU&gt;30KVA, additional central NS protection shall be provided at the central meter panel</p>	P



VDE-AR-N 4105:2011 in conjunction with E DIN V VDE V 0124-100:2013			
Clause	Requirement - Test	Result - Remark	Verdict
6.2	<p><b>Central NS protection</b></p> <p>The central NS protection shall be accommodated as independent apparatus in a suitable circuit distributor in accordance with TAB 2007, Clause 8, Paragraph 1, and not in the upper connection compartment specified in TAB 2007, 7.2, Paragraph 9 and connected to the central meter panel.</p>		N/A
6.3	<p><b>Integrated NS protection</b></p> <p>The NS protection can be integrated in the programmable system control of the power generation units. If so, then both the test button and the sealing may be omitted, however, password protection is required, if the protective function U &gt; is adjustable.</p>		P
6.4	<p><b>Interface switch</b></p>		P
6.4.1	<p><b>General</b></p> <p>For the connection of the power generation system to the network operator's low-voltage network or to the remaining customer system, it is necessary to use an interface switch. It consists of two electric switching devices connected in series and shall thus be constructed redundantly. The interface switch is controlled by the NS protection and activates automatically if at least one protective function responds.</p> <p>The breaking devices of the interface switch shall be designed to be short-circuit proof and shall be releasable without delay and with due regard to the protective devices required by clause 6.5. The breaking capacity of the two breaking devices of the interface switch shall be dimensioned at least in accordance with the responding range of the upstream safety fuse or the maximum short-circuit current contribution of the power generation system.</p> <p>Switches with at least breaking capacity shall be use for both breaking devices of the interface switch. In addition to that, all-pole disconnection shall be ensured.</p>	<p>Integrated power relay in the PGU. Each live conductor is constructed with two relays comply with A.6 requirement.</p>	P
6.4.2	<p><b>Central interface switch</b></p> <p>The two break devices of the central interface switch shall be executed as galvanic break devices.</p> <p>The two break devices of the interface switch shall be installed directly at the central meter panel in the circuit distributor of the power generation system.</p>		N/A

VDE-AR-N 4105:2011 in conjunction with E DIN V VDE V 0124-100:2013			
Clause	Requirement - Test	Result - Remark	Verdict
6.4.3	<p><b>Integrated interface switch</b></p> <p>Construction of the interface switch shall be carried out taking into consideration the single-fault tolerance.</p> <p>An interface switch ensures a single-fault tolerant all-phase galvanic breaking.</p> <p>For power generation systems with inverters, the interface switch shall be provided on the inverter's network side. A short circuit in the inverter shall not impair the switching function of the interface switch.</p>	Two series relays	P
6.5	<b>Protective devices for the interface switch</b>		P
	Comments:		
6.5.1	<p><b>General</b></p> <p>The purpose of the NS protection is to disconnect the power generation system from the net in the event of inadmissible voltage and frequency values. This is intended to prevent an unintentional feed-in of the power generation system into a power-supply unit separated from the remaining distribution network as well as the feed-in of faults within this network.</p> <p>The system operator shall himself take precautions to prevent damages to his systems and installations as might be caused by switching actions, voltage fluctuations and automatic reclosings in the network connected upstream or other process in the network of the network operator.</p> <p>The following functions of the decoupling protection shall be implemented:</p> <ul style="list-style-type: none"> <li>- Voltage drop protection <math>U &lt;</math>;</li> <li>- Rise-in-voltage protection <math>U &gt;</math>;</li> <li>- Rise-in-voltage protection <math>U &gt;&gt;</math>;</li> <li>- Frequency decrease protection <math>f &lt;</math>;</li> <li>- Frequency increase protection <math>f &gt;</math>;</li> <li>- Islanding detection.</li> </ul> <p>The setting values of the protective functions and the last five dated failure reports shall be readable at the NS protection. Interruptions of supply with durations of 3 s or longer shall not lead to loss of any of the failure reports. Read-out shall be possible at the central NS protection irrespective of the operational state of the power generation system and without any additional aids. For integrated NS protection read-out may be carried out using a data interface.</p>		P

VDE-AR-N 4105:2011 in conjunction with E DIN V VDE V 0124-100:2013			
Clause	Requirement - Test	Result - Remark	Verdict
6.5.2	<p><b>Protective functions</b></p> <p>The protective functions of the NS protection shall be designed so that the disconnection time (the sum of the proper times of NS protection and interface switch plus a delay for the protection relay, which may or may not be adjustable) does not exceed 200 ms.</p>	PGU compliance with this function and not exceed 200 ms	P
6.5.3	<p><b>Islanding detection</b></p> <p>The islanding detection is implemented in the central NS protection or in the integrated NS protection of the power generation unit. If an islanding detection system acting on the integrated interface switch is integrated in all power generation units of a power generation system, then it is permitted to omit the islanding detection in the central NS protection regardless of the system power.</p> <p>Detection of an isolated network and disconnection of the power generation system by means of the interface switch shall be completed within 5 seconds.</p>	PGU compliance with this function and does not exceed 5s	P
<b>7</b>	<b>Metering for billing purposes</b>		N/A
	<p>Installation and operation of the measuring devices shall be agreed in due time between the system operator and the network or metering point operator, respectively.</p> <p>According to the German Calibration Act, only certified and calibrated meters and transformers shall be used in the course of business.</p>		N/A
<b>8</b>	<b>Operation of the system</b>		<b>P</b>

VDE-AR-N 4105:2011 in conjunction with E DIN V VDE V 0124-100:2013			
Clause	Requirement - Test	Result - Remark	Verdict
8.1	<p><b>General</b></p> <p>The operation of electrical installations included all technical and organisational activities required to ensure the functional efficiency and safety of the systems. These activities include all operating measures as well as electrical and non-electrical operations as described in the applicable rules and regulations.</p> <p>For connection of the power generator systems, the conditions given in 8.3 shall be satisfied. During operation, the conditions of clause 5, which the decisions regarding the connection of the power generation system were based on, shall only be changed with the consent of the network operator.</p> <p>The system operator shall ensure that the equipment - required for parallel operation with the low-voltage network is always in proper technical condition. It is required to have an electrically skilled person check the switches and protective devices for proper functioning at regular intervals. This requirement is deemed to be satisfied for normal operating and environmental conditions if the test intervals mentioned in BGV A3 or TRBS 1201 are adhered to. Te repeat tests shall include at least the following:</p> <ul style="list-style-type: none"> <li>- Check of the environmental conditions and elimination of deficiencies, if required;</li> <li>- Tripping control of the interface switch.</li> </ul> <p>Power reduction or disconnection required due to network conditions: upon request of the network operator, the system operator is obliged to switch off the power generation system or to disconnect it from the network if this is required for conduction work that are necessary for operational purposes in the network operator's network.</p> <p>Access: upon co-ordination with the system operator, the network operator shall be granted access to all components of the power generation system, interfaces switch, facilities of the power generation/ network security management, and the power generation units.</p> <p>Exchange of information: the network operator will inform the system operator about substantial modifications in his network which will have an impact on the current parallel operation.</p> <p>Coupling of network connection points: different network connection points on the network of the network operator shall not be operated in galvanic connection through systems of one or more system operators.</p> <p>Behaviour in the event of disturbances: the reconnection</p>	<p>The PGU is type tested in term of this standard and the installation into PGS shall also comply with this standard.</p> <p>The PGU can be informed to reduce the power output. The installation of PGS shall be considered with consent of network operator.</p>	P

VDE-AR-N 4105:2011 in conjunction with E DIN V VDE V 0124-100:2013			
Clause	Requirement - Test	Result - Remark	Verdict
	conditions given in 8.3 shall be satisfied.		
8.2	<p><b>Particular characteristics of the management of the network operator's network</b></p> <ul style="list-style-type: none"> <li>- Earthing and short-circuiting for works on the network: After isolation, a prerequisite for the safety of works on the network is to prevent any voltage sources from reconnecting unintentionally.</li> <li>- Operation of the network stand-by systems: For certain works on the network, the network operator has to disconnect sub-networks from the remaining network. In order to ensure continuous supply to the customers during this time, the network operator may use network stand-by systems. Normally, the network operator will inform the customers concerned about the use and operation of network stand-by systems.</li> </ul>	Considered in final PGS installation	N/A
8.3	<b>Connection conditions and synchronisation</b>		P
8.3.1	<p><b>General</b></p> <p>A power generation system shall be connected to the network operator's network only if a suitable device determines that both the mains voltage and the mains frequency are within the tolerance range of 85 % Un to 110 % Un or 47.5 Hz to 50.05 Hz, respectively, for a period of at least 60 seconds.</p> <p>If decoupling protection devices are tripped because of a short interruption, then the power generation system is permitted to already reconnect as soon as the mains voltage and mains frequency have uninterruptedly remained within the tolerance ranges given above for a period of 5 seconds. Short time interruptions are characterised by the NS protection settings of the mains frequency and/ or network voltage being exceeded or undershot for a maximum period of 3 seconds.</p> <p>The power generation system being reconnected to the network operator's network at the tripping of the decoupling protection device, the active power of controllable power generation systems supplied to the network operator's network shall not exceed the gradient of 10 % of the active power per minute.</p>	(See appended table)	P

VDE-AR-N 4105:2011 in conjunction with E DIN V VDE V 0124-100:2013			
Clause	Requirement - Test	Result - Remark	Verdict
8.3.2	<p><b>Connection of synchronous generators</b></p> <p>A synchronisation device shall be provided in a suitable place for synchronous generators coupled directly to the network.</p>		N/A
8.3.3	<p><b>Connection of asynchronous generator</b></p> <p>For asynchronous generators started by a prime mover and connected at a rotational speed between 95 % and 105 % of the synchronous rotational speed, <math>k_{imax}</math> is expected to be = 4.</p>		N/A
8.3.4	<p><b>Connection of power generation units with inverters</b></p> <p>Power generation units with inverters shall only be connected with <math>k_{imax} \leq 1.2</math>.</p>	The $k_{imax}$ is 0.779	P
8.4	<p><b>Reactive power compensation</b></p> <p>Equipment for reactive power compensation shall either: be connected or disconnected together with the consumption devices or power generation systems; or operated via control equipment.</p>	See clause 5.7.5	P

VDE-AR-N 4105:2011 in conjunction with E DIN V VDE V 0124-100:2013			
Clause	Requirement - Test	Result - Remark	Verdict
<b>9</b>	<b>Verification of the electrical properties</b>		<b>P</b>
9.1	<p><b>General</b></p> <p>The certificates of conformity issued for the power generation units and the NS protection shall confirm their conformity with requirements of this VDE application guide at least with regard to the properties described in 9.2 to 9.4.</p>		P
9.2	<b>Verification of the feed-in power</b>		<b>P</b>
9.2.1	<p><b>Verification of the feed-in power</b></p> <p>For power generation units, it is sufficient to indicate the maximum active power feed-in.</p>		P
9.2.2	<p><b>Verification of the reactive power values</b></p> <p>Indication of the maximum reactive powers for inductive and maximum capacitive reactive power extraction as a function of the feed-in active power is required. For this at least the conditions give in 5.7.5 shall be satisfied.</p> <p>For power generations units with a generator directly coupled to the network which, due its very operational principle, cannot control the reactive power and, therefore, uses non-controllable, fixed capacities <math>\cos\phi</math> shall be reached within 60 seconds. The maximum deviation at <math>\cos\phi</math> nominal voltage shall be 0.02.</p>		P
9.2.3	<p><b>Verification of the reactive power transition function</b></p> <p>In order to check the standard characteristic curve <math>\cos\phi</math> (P) given in 5.7.5, the change of the active power mode of operation is to be checked in correspondence to the magnitude of the active power feed-in.</p>		P
9.3	<p><b>Verification of the network reactions</b></p> <p>In order to verify the permissible network reactions specified in 5.4, it is required to submit evidence provided by the manufacturer for the radiated interference produced by the power generation unit.</p>		P
9.4	<p><b>Verification of the features of the network and system protection</b></p> <p>Compliance with the conditions required by Clause 6 for NS protection for the protection against inadmissible voltage and frequency increase/decrease shall be verified based on measurements.</p>		P

VDE-AR-N 4105:2011 in conjunction with E DIN V VDE V 0124-100:2013			
Clause	Requirement - Test	Result - Remark	Verdict
	<b>Annex A: Explanations (informative)</b>		--
	<b>Annex B: Connection examples (informative)</b>		--
	<b>Annex C: Examples of meter panel configurations (informative)</b>		--
	<b>Annex D: Islanding detection (normative)</b>		<b>P</b>
D.1	Islanding detection by means of the oscillation circuit test		P
D.2	Islanding detection by three-phase voltage monitoring		N/A
	<b>Annex E: Examples for the connection evaluation of power generation systems (informative)</b>		--
	<b>Annex F: Forms (mandatory)</b>		<b>P</b>
F.1	Initial start-up protocol – Power generation systems, low voltage		N/A
F.2	Data sheet for power generation systems		P
F.3	Requirements for the test report for power generation units		P
F.4	Requirements for the test report for the NS protection		N/A
	<b>Annex G: Forms (optional) (informative)</b>		N/A
G.1	<b>Application</b>		N/A
G.2	<b>Certificate of conformity for power generation units</b>		N/A
G.3	<b>Certificate of conformity of the network and system protection</b>		N/A



Appendix 1- Test Result

5.7.3.2		Table: Generation management/network security management (the signal of the reference value must be reduced from 100%, 90% ...10% P <sub>n</sub> )					P
String	1	U <sub>DC</sub> = Un	50 Vdc	U <sub>ac</sub> = Un	230Vac	P = (W)	3000 W
P (W)				P (W)			
100%				2967.45W			
90%				2698.81W			
80%				2402.06W			
70%				2105.22W			
60%				1808.69W			
50%				1512.60W			
40%				1217.64W			
30%				892.98W			
20%				597.78W			
10%				301.11W			
Supplementary information:							

5.7.3.3		Table: Active poewr output feed-in at overfrequency				P
> 80% P <sub>Emax</sub>						
40%P <sub>M</sub> (W)		1190.62		10%P <sub>Emax</sub> (W)		300
f (Hz)	Measured output Power (W)	Measured $\Sigma P = P_{\text{measured}} - P_M$ (W)		Calculated from standard characteristic curve P (W)	Tolerance between measured P and calculated P (W)	
50Hz ± 0.01Hz	50.00	2976.56		--	--	
50.25Hz ± 0.05Hz	50.25	2937.98		38.58	2917.03	
50.70Hz ± 0.10Hz	50.70	2419.72		556.84	2381.25	
51.15Hz ± 0.05Hz	51.15	1886.98		1089.58	1845.47	
50.70Hz ± 0.10Hz	50.70	2420.98		555.98	2381.25	
50.25Hz ± 0.05Hz	50.25	2941.37		35.19	2917.03	
50Hz ± 0.01Hz	50.00	2969.93		--	--	
40% ~ 60% of P <sub>Emax</sub>						
40%P <sub>M</sub> (W)		600.30		10%P <sub>Emax</sub> (W)		300
f (Hz)	Measured output Power (W)	Measured $\Sigma P = P_{\text{measured}} - P_M$ (W)		Calculated from standard characteristic curve P (W)	Tolerance between measured P and calculated P (W)	
50Hz ± 0.01Hz	50.00	1500.76		--	--	
50.25Hz ± 0.05Hz	50.25	1466.99		33.77	1470.74	
50.70Hz ± 0.10Hz	50.70	1206.73		294.03	1200.61	
51.15Hz ± 0.05Hz	51.15	942.31		558.45	930.48	
50.70Hz ± 0.10Hz	50.70	1206.99		293.77	1200.61	
50.25Hz ± 0.05Hz	50.25	1465.45		35.31	1470.74	
50Hz ± 0.01Hz	50.00	1501.59		--	--	
Supplementary information:						
Amplitude increase or decrease of 40%P <sub>m</sub> /Hz, the tolerance is less than or equal to 10%P						

**Appendix 1- Test Result**

--

	> 80% P <sub>E<sub>max</sub></sub> · Disconnection from the network?	Trip time (ms)	40% ~ 60% of PE <sub>max</sub> Disconnection from the network?	Trip time (ms)	Remark
51.65Hz ± 0.05Hz	<input checked="" type="checkbox"/> Yes <input type="checkbox"/> No	153.0	<input checked="" type="checkbox"/> Yes <input type="checkbox"/> No	160.5	--
	Start up?		Start up?		Gradient (W/min)
50.1Hz ± 0.01Hz	<input type="checkbox"/> Yes <input checked="" type="checkbox"/> No		<input type="checkbox"/> Yes <input checked="" type="checkbox"/> No		--
50Hz ± 0.01Hz	<input checked="" type="checkbox"/> Yes <input type="checkbox"/> No		<input checked="" type="checkbox"/> Yes <input type="checkbox"/> No		266.67

5.7.5	Measurement of the Range of Power and of the Reactive Power			
DC input:	AC output: 1.0Un			Rated Active Power
50 Vdc	230 Vac; 50 Hz			3.0kW
Measurement Item	cosφ	Apparent Power (VA)	Active Power (W)	Reactive Power (Var)
a)	0.9991	2986.31	2983.71	-124.37
b)	0.8983	3046.40	2736.63	1338.42
c)	0.9043	2966.43	2682.41	-1266.63
d)	0.9014	687.05	619.30	297.49
	0.8983	1017.57	914.06	447.14
e)	0.8997	713.90	642.31	-311.60
	0.9051	1028.61	931.00	-437.34
DC input:	AC output: 1.09Un			Rated Active Power
50 Vdc	250.7 Vac; 50 Hz			3.0 kW
Measurement Item	cosφ	Apparent Power (VA)	Active Power (kW)	Reactive Power (Var)
a)	0.9988	2975.58	2971.98	-146.15
b)	0.9063	3056.79	2770.48	1291.67
c)	0.9064	2967.04	2689.20	-1253.61
d)	0.8973	672.33	603.27	296.80
	0.8997	1007.38	906.35	439.70
e)	0.8943	705.89	631.26	-315.89
	0.8994	1033.92	929.91	-451.95
S <sub>E<sub>max</sub></sub> (VA)	3056.79			
P <sub>E<sub>max</sub></sub> (W)	2983.71			
Remark: negative denotes lagging, positive denotes leading.				

5.7.5		Testing for the cos φ adjustment accuracy							
		91% Un				109% Un			
Step	S(VA)	P(W)	Q(VAR)	cosφ	Step	S(VA)	P(W)	Q(VAR)	cosφ
a)	--	--	--	--	a)	--	--	--	--
S <sub>max</sub>	--	--	--	--	S <sub>max</sub>	--	--	--	--
b)	--	--	--	--	b)	--	--	--	--
S <sub>max</sub>	--	--	--	--	S <sub>max</sub>	--	--	--	--
c)	--	--	--	--	c)	--	--	--	--
S <sub>max</sub>	--	--	--	--	S <sub>max</sub>	--	--	--	--
d)	1995.64	1807.70	-845.47	0.9058	d)	1319.40	1189.45	-570.97	0.9015
S <sub>max</sub>	2769.83	2497.91	-1196.82	0.9018	S <sub>max</sub>	3055.63	2739.45	-1353.61	0.8965

**Appendix 1- Test Result**

e)	1998.93	1795.53	878.51	0.8982	e)	1320.70	1184.38	-584.38	0.8968
Smax	2704.08	2439.41	1166.76	0.9021	Smax	2963.91	2687.56	-1249.72	0.9067
Remark: negative denotes lagging, positive denotes leading.									

5.7.5		Testing of a displacement factor/active power characteristic curve $\cos\phi(P)$								
Step		20% $P_{E_{max}}$	30% $P_{E_{max}}$	40% $P_{E_{max}}$	50% $P_{E_{max}}$	60% $P_{E_{max}}$	70% $P_{E_{max}}$	80% $P_{E_{max}}$	90% $P_{E_{max}}$	100% $P_{E_{max}}$
a)	P(kW)	605.16	905.57	1218.69	1499.56	1810.02	2116.33	2422.14	2736.41	--
	Cos $\phi$ (actual)	0.9620	0.9920	0.9958	0.9973	0.9775	0.9592	0.9419	0.9238	--
	Cos $\phi$ (limit)	0.90leading ~0.90lagging	1	1	1	0.98	0.96	0.94	0.92	0.90
b)	P(kW)	627.63	--	--	1502.79	--	--	--	2723.95	--
	Cos $\phi$ (actual)	0.9640	--	--	0.9973	--	--	--	0.9238	--
	Cos $\phi$ (limit)	0.90leading ~0.90lagging	--	--	1	--	--	--	0.92	--
	Settling time (actual)	8s	--	--	8s	--	--	--	7s	--
	Settling time (limit)	10s	--	--	10s	--	--	--	10s	--

**Appendix 1- Test Result**

6.1 (6.5.1)		TABLE: General requirements				P	
<p>Design of functional safety:</p> <p>The circuits designed consist of Microcontroller main CPU (Control A) and slave CPU (Control B). The main CPU (Control A) control high frequency transformer driver, inverter driver and DC-DC driver; measures the battery voltage, current, temperature and measures grid voltage, frequency, AC current with injected DC components; In addition it can communicate with slave CPU and send the control signal , also tests the relay and the RCMU circuit before each start up.</p> <p>The CPU (Control B) is communicated with CPU (Control A) and can switch off the relays independently , once does not receive the signal from the main CPU, it also switch off the relay, ensure to isolate the grid and load.</p> <p>The current is measured by a current sensor. The AC current signal and the injected DC current signal are sent to the main CPU. The main CPU tests and calibrates before each start up all current sensors.</p> <p>The unit provides two relays in series in L/N conductors. When single fault applied to one relay, alarm and error code in display panel, the relay and transformer provides basic insulation maintained between the battery and the mains. All the relays are tested before each start up.</p>							
<p>Supplementary information:</p> <p>the relay and transformer provides basic insulation between the Grid and battery input.</p>							
String	1	$U_{DC} = U_n$	50Vdc	$U_{ac} = U_n$	230Vac	P = (W)	3.0K
Component No.		Fault		Observation			
EC2		S/C		The PCE shutdown immediately, and disconnect from the grid. No hazards			
C196		S/C		The PCE can operate normally, but the communication fails. No hazards			
C197		S/C		The PCE switch off immediately, and disconnect from the grid, error code "ID17, ID18, ID19" display. No hazards			
RY1		S/C		The PCE check relay fail before power on, error code "ID55, ID77" display. No hazards			
HCT (12-13)		S/C)		The PCE switch off immediately, and disconnect from the grid, error code "ID10" display. No hazards			
Q2 (C-G)		S/C		The PCE shutdown immediately, components Q2,Q8, R26,R27, Q4, Q24 damaged. No hazards			
Q2 (C-E)		S/C		The PCE shutdown immediately, components Q8, C17, R44, Q3, C10, R25, Q7, R37 damaged. No hazards			
Q3 (C-G)		S/C		The PCE shutdown immediately, components Q3, R28, R29, Q5, and U23 damaged. No hazards			
Q3 (C-E)		S/C		The PCE shutdown immediately, components Q7, C16, R39, R37, R38, Q8, C17, and R44 damaged. No hazards			
Q14		S/C		The PCE shutdown immediately, components Q14, R80, R73, and Q15 damaged. No hazards			
QD2 (C-G)		S/C		The PCE shutdown immediately, components QD2, R76, R78, Q18, QD3 and U30 damaged. No hazards			
QD2 (C-E)		S/C		The PCE shutdown immediately, components QD3, R96, R94, Q21, QD4 and U33 damaged. No hazards			
QD1 (C-E)		S/C		The PCE shutdown immediately, components QD4, R93, R95, and QD2 damaged. No hazards			
QD1 (C-G)		S/C		The PCE shutdown immediately, components QD1, Q18, R76, and R83 damaged. No hazards			

**Appendix 1- Test Result**

EC2	S/C	The PCE shutdown immediately, components Q14, Q19, Q2, Q8, QD1 and QD3 damaged. No hazards
RD1	O/C	The PCE switch off immediately, and disconnect from the grid, error code "ID29, ID25" display. No hazards
RD5	O/C	The PCE switch off immediately, and disconnect from the grid, error code "ID29, ID25" display. No hazards
Q54 (D-S)	S/C	The PCE shutdown immediately, components Q62, Q63, R104, C63, R105 and Q64 damaged. No hazards
Q60 (D-S)	S/C	The PCE shutdown immediately, components Q64, Q65, R106, C65, R103 and Q66 damaged. No hazards
C39	S/C	The PCE shutdown immediately, components RT618, D5 and D8 damaged. No hazards
EC9	S/C	The PCE shutdown immediately, and disconnect from the grid. No hazards
EC11	S/C	The PCE shutdown immediately, and disconnect from the grid. No hazards
EC13	S/C	The PCE shutdown immediately, and disconnect from the grid. No hazards
EC18	S/C	The PCE shutdown immediately, and disconnect from the grid. No hazards
Q24 (G-D)	S/C	The PCE shutdown immediately, components Q24, R127 and U6 damaged. No hazards
Q24 (D-S)	S/C	The PCE shutdown immediately, components Q24, R137, R138, and R135 damaged. No hazards
ECF31	S/C	The PCE switch off immediately, and disconnect from the grid, error "communication fails" display. No hazards
<p>Supplementary information:</p> <p>SC: Short-circuited; OC: Open-circuited; O/L: Overloaded.</p> <p>During the test:</p> <p>Fire do not propagates beyond the EUT; Equipment do not emitt molten metal;</p> <p>Enclosures do not deform to cause non-compliance with the standard.</p> <p>Pass the dielectric test.</p>		

6.5.2	Protective functions (Results of Voltage monitoring)						
	Rated Voltage (Un)	230V		Rated Frequency		50 Hz	
		1		2		3	
		(V)	(ms)	(V)	(ms)	(V)	(ms)
	118% Un	271.4	165.5	271.4	153.5	271.4	162.0
	77% Un	177.1	167.0	177.1	161.5	177.1	164.5

6.5.2	Protective functions (Results of the Protection of the Increase in Voltage as 10-min moving average)			
	Output Voltage (V)	Switch		
		On/Off state Finally		Time until Switch off (s)
	100% Un	230.0	<input checked="" type="checkbox"/> On <input type="checkbox"/> Off	Work normally
	112% Un	257.6	<input type="checkbox"/> On <input checked="" type="checkbox"/> Off	507s
	100% Un	230.0	<input checked="" type="checkbox"/> On <input type="checkbox"/> Off	Work normally
	108% Un	248.4	<input checked="" type="checkbox"/> On <input type="checkbox"/> Off	Work normally

**Appendix 1- Test Result**

106% Un	243.8	<input checked="" type="checkbox"/> On <input type="checkbox"/> Off	Work normally
114% Un	262.2	<input type="checkbox"/> On <input checked="" type="checkbox"/> Off	248s

6.5.2	Protective functions (Results of Frequency)					
	1		2		3	
	f (Hz)	Trip time (ms)	f (Hz)	Trip time (ms)	f (Hz)	Trip time (ms)
Frequency decrease	47.48	154.5	47.48	170.5	47.48	162.5
Frequency increase	51.51	134.5	51.51	160.5	51.51	153.0

6.5.3	TABLE: Detection of islanding operation					P
Test conditions:	Frequency: 50+/-0,2Hz U <sub>N</sub> =230+/-3Vac RLC consumes inverter real power within +/-3% Distortion factor of chokes <3% Quality Q>2					
P = 1.0 P <sub>N</sub> = (W)	3000W	P = 0.5 P <sub>N</sub> = (W)	1500W	P = 0.25 P <sub>N</sub> = (W)	750W	
Q <sub>L</sub> = 6330Var	Cut-off time (ms)	Q <sub>L</sub> = 3165Var	Cut-off time (ms)	Q <sub>L</sub> = 1583Var	Cut-off time (ms)	
95%	245.5	95%	378.5	95%	326.5	
96%	258.5	96%	475.0	96%	523.5	
97%	310.0	97%	485.5	97%	835.0	
98%	306.0	98%	420.0	98%	884.0	
99%	455.0	99%	611.0	99%	907.5	
100%	433.5	100%	408.0	100%	872.0	
101%	464.0	101%	431.0	101%	902.0	
102%	362.0	102%	562.0	102%	492.5	
103%	339.5	103%	472.5	103%	844.0	
104%	328.0	104%	413.0	104%	853.0	
105%	336.0	105%	448.0	105%	498.0	

8.3.1 (5.5.1 & 5.5.2)	Connection conditions		
DC input:	AC output:		Rated Output Power
50Vdc	230Vac;	50Hz	3.0kW
Measure Item	Reconnection?		Reconnection Time (>60s)
f <sub>ist</sub> = 47,45Hz	<input type="checkbox"/> Yes	<input checked="" type="checkbox"/> No	Cannot reconnection
f <sub>ist</sub> ≥ 47,55Hz	<input checked="" type="checkbox"/> Yes	<input type="checkbox"/> No	69.8s
f <sub>ist</sub> = 50,1Hz	<input type="checkbox"/> Yes	<input checked="" type="checkbox"/> No	Cannot reconnection
f <sub>ist</sub> ≤ 50,0Hz	<input checked="" type="checkbox"/> Yes	<input type="checkbox"/> No	69.8s
U <sub>ist</sub> < 85% U <sub>n</sub>	<input type="checkbox"/> Yes	<input checked="" type="checkbox"/> No	Cannot reconnection
U <sub>ist</sub> ≥ 85% U <sub>n</sub>	<input checked="" type="checkbox"/> Yes	<input type="checkbox"/> No	70.0s
U <sub>ist</sub> > 110% U <sub>n</sub>	<input type="checkbox"/> Yes	<input checked="" type="checkbox"/> No	Cannot reconnection
U <sub>ist</sub> ≤ 110% U <sub>n</sub>	<input checked="" type="checkbox"/> Yes	<input type="checkbox"/> No	64.0s

**Appendix 1- Test Result**

8.3.1 (5.5.1 & 5.5.2)	Short-time Interruption								
	1			2			3		
	U <sub>n</sub> (V)	Repeated Time (s)	Gradient (W/min)	U <sub>n</sub> (V)	Repeated Time (s)	Gradient (W/min)	U <sub>n</sub> (V)	Repeated Time (s)	Gradient (W/min)
After 2s of 77% U <sub>n</sub>	230	71.6	266.67	230	72.2	266.67	230	71.8	266.67
After 4s of 77% U <sub>n</sub>	230	74.3	266.67	230	74.3	266.67	230	74.0	266.67

Appendix 1- Test Result

**F.3 Requirements for the test report for power generation units**

Extract from test report for unit certificate: 161008074GZU-001												
Determination of electrical properties												
Installation Type:	AC-coupled Storage Converter											
Manufacturer:	Shenzhen SOFARSOLAR Co., Ltd.											
Rated Voltage:	230V											
<b>Reactive power reference</b>												
Active power $P/P_n(\%)$	10	20	30	40	50	60	70	80	90	100		
Max. possible $\cos \varphi$ underexcited	0.7096	0.7702	0.7982	0.8059	0.8023	0.8020	0.8058	0.8089	--	--		
Max. possible $\cos \varphi$ overexcited	0.8186	0.8141	0.8089	0.8043	0.8011	0.7989	0.7983	0.7958	--	--		
<b>Compliance of required displacement factor <math>\cos \varphi</math></b>												
Default in system control	0.90 over	0.92 over	0.94 over	0.96 over	0.98 over	1.00	0.98 under	0.96 under	0.94 under	0.92 under	0.90 under	
Measured value at PGU terminals	--	0.9285	0.9386	0.9597	0.9788	0.9973	0.9775	0.9592	0.9419	0.9238	--	
<b>Reactive power transfer function – Standard-<math>\cos \varphi</math>-(P)-characteristic</b>												
Active power $P/P_n(\%)$	10	20	30	40	50	60	70	80	90	100		
$\cos \varphi$	0.8945	0.9620	0.9920	0.9958	0.9973	0.9775	0.9592	0.9419	0.9238	--		
Conform to Standard- $\cos \varphi$ -(P)-characteristic												
<b>Switching actions</b>												
Making operation without default (of primary energy carrier)						$k_i$						--
Worst case at switch over of generator sections						$k_i$						--
Making operation at reference conditions (of primary energy carrier)						$k_i$						--
Breaking operation at nominal power						$k_i$						--
Worst-case value of all switching operations						$k_{imax}$						0.779
<b>Flicker</b>												
Angle of network impedance $\psi_k$ :												32°
Long-term flicker strength Plt:												0.029



**Appendix 1- Test Result**

<b>5.4.4 Harmonics and inter-harmonics</b> (Harmonics according to DIN EN 61000-3-12)											
Load current: <u>100</u> %											
Harm. order h	1	2	3	4	5	6	7	8	9	10	
Current (A)	12.8948	0.0127	0.2251	0.0076	0.0560	0.0217	0.1426	0.0078	0.0404	0.0137	
Limit (A)	--	1.08	2.30	0.43	1.14	0.30	0.77	0.23	0.40	0.184	
Harm. order h	11	12	13	14	15	16	17	18	19	20	
Current (A)	0.1217	0.0121	0.0089	0.0086	0.0856	0.0052	0.0381	0.0033	0.0481	0.0031	
Limit (A)	0.33000	0.15333	0.21000	0.13143	0.15000	0.11500	0.13235	0.10222	0.11842	0.09200	
Harm. order h	21	22	23	24	25	26	27	28	29	30	
Current (A)	0.0484	0.0052	0.0258	0.0034	0.0399	0.0119	0.0239	0.0049	0.0240	0.0094	
Limit (A)	0.10714	0.08364	0.09783	0.07667	0.09000	0.07077	0.08333	0.06571	0.07759	0.06133	
Harm. order h	31	32	33	34	35	36	37	38	39	40	
Current (A)	0.0213	0.0006	0.0186	0.0031	0.0153	0.0063	0.0177	0.0082	0.0121	0.0023	
Limit (A)	0.07258	0.05750	0.06818	0.05412	0.06429	0.05111	0.06081	0.04842	0.05769	0.04600	
<b>THD (%)</b>	<b>2.59</b>					<b>PWHD(%)</b>					--
<b>Limit (%)</b>	<b>5.0</b>					<b>Limit (%)</b>					--

5.4.4 Harmonics and inter-harmonics											
Power P/Pn[%]	0	10	20	30	40	50	60	70	80	90	100
Harmonic number	I [%]	I [%]	I [%]	I [%]	I [%]	I [%]	I [%]	I [%]	I [%]	I [%]	I [%]
2	0	1.3207	0.5776	0.3808	0.2691	0.2462	0.1932	0.1524	0.1224	0.1071	0.0987
3	0	5.4877	3.3357	2.5050	1.8947	1.6028	1.3743	1.2124	1.0632	0.9891	1.7453
4	0	0.6571	0.2663	0.1263	0.0800	0.0981	0.0525	0.0647	0.0695	0.0565	0.0593
5	0	2.6854	1.4085	1.0651	0.8339	0.6469	0.5959	0.5017	0.4106	0.3621	0.4343
6	0	0.0878	0.0300	0.0053	0.0928	0.0414	0.0906	0.0940	0.1406	0.1163	0.1681
7	0	2.1929	0.7756	0.5812	0.5142	0.3873	0.4615	0.3904	0.3232	0.2725	1.1058
8	0	0.1843	0.0923	0.1039	0.1495	0.0939	0.1232	0.1344	0.1242	0.0931	0.0606
9	0	1.1738	0.5490	0.3153	0.3467	0.3462	0.4331	0.4265	0.3339	0.2853	0.3132
10	0	0.4810	0.1758	0.1141	0.0859	0.0216	0.0517	0.1145	0.1152	0.1217	0.1065
11	0	1.0669	0.3999	0.2313	0.2956	0.3601	0.4644	0.4249	0.3492	0.3258	0.9440
12	0	0.4069	0.1416	0.1572	0.1540	0.0892	0.1070	0.1280	0.1184	0.0838	0.0936
13	0	0.5940	0.2325	0.2401	0.3120	0.3590	0.5044	0.4347	0.3726	0.3365	0.0694
14	0	0.2570	0.0453	0.0759	0.0717	0.0359	0.0493	0.0835	0.0781	0.0656	0.0665
15	0	0.3615	0.1221	0.2412	0.3782	0.3877	0.4807	0.4424	0.3694	0.3349	0.6639
16	0	0.3607	0.2081	0.0697	0.0791	0.0289	0.0385	0.0843	0.0770	0.0461	0.0404
17	0	0.3425	0.1609	0.2438	0.3476	0.3754	0.4391	0.4156	0.3582	0.3227	0.2951
18	0	0.1567	0.0899	0.1213	0.0439	0.0451	0.0191	0.0317	0.0481	0.0447	0.0257
19	0	0.3370	0.1012	0.2256	0.3407	0.3510	0.4198	0.3936	0.3373	0.3001	0.3728
20	0	0.1298	0.0500	0.0830	0.0596	0.0292	0.0326	0.0416	0.0440	0.0318	0.0242
21	0	0.3793	0.1580	0.1893	0.3131	0.3283	0.3828	0.3453	0.2964	0.2771	0.3757
22	0	0.3975	0.1624	0.0645	0.0355	0.0184	0.0308	0.0637	0.0706	0.0589	0.0406
23	0	0.2745	0.1895	0.1477	0.2708	0.3110	0.3346	0.3100	0.2639	0.2466	0.2002
24	0	0.3727	0.2405	0.1140	0.0671	0.0412	0.0482	0.0534	0.0516	0.0476	0.0264
25	0	0.2919	0.2229	0.1197	0.2306	0.2558	0.2862	0.2768	0.2425	0.2270	0.3098
26	0	0.1754	0.0911	0.0527	0.0360	0.0477	0.0737	0.0781	0.0706	0.0546	0.0922
27	0	0.5661	0.2285	0.0670	0.1778	0.2249	0.2537	0.2403	0.2156	0.2119	0.1857
28	0	0.1336	0.0882	0.0856	0.0530	0.0375	0.0479	0.0581	0.0441	0.0516	0.0377
29	0	0.4865	0.1517	0.0452	0.1405	0.1917	0.2215	0.2066	0.1988	0.1918	0.1858
30	0	0.2478	0.1516	0.1499	0.1016	0.0541	0.0427	0.0439	0.0384	0.0295	0.0727
31	0	0.4503	0.2195	0.0607	0.1074	0.1510	0.1856	0.1763	0.1682	0.1716	0.1649
32	0	0.3665	0.1991	0.1590	0.1025	0.0740	0.0442	0.0263	0.0404	0.0370	0.0050
33	0	0.4250	0.2337	0.0707	0.0930	0.1172	0.1481	0.1570	0.1533	0.1527	0.1440
34	0	0.2591	0.1170	0.1400	0.0748	0.0528	0.0438	0.0234	0.0251	0.0248	0.0243
35	0	0.6387	0.3101	0.0883	0.0874	0.1126	0.1308	0.1351	0.1395	0.1431	0.1185
36	0	0.1460	0.1028	0.1132	0.0704	0.0531	0.0494	0.0255	0.0245	0.0174	0.0490
37	0	0.5115	0.3647	0.1082	0.0659	0.0834	0.1015	0.1224	0.1259	0.1205	0.1371
38	0	0.2006	0.0582	0.0776	0.0527	0.0480	0.0397	0.0155	0.0221	0.0198	0.0633
39	0	0.3279	0.3707	0.1292	0.0904	0.0849	0.0939	0.1125	0.1118	0.1221	0.0937
40	0	0.1780	0.0425	0.0665	0.0424	0.0431	0.0438	0.0310	0.0369	0.0208	0.0175

### F.4 Requirements for the test report for the NS protection

Extract from test report for unit certificate: 161008074GZU-001							
Determination of electrical properties							
<input checked="" type="checkbox"/> NS protection as integrated NS protection							
<b>Type of NS protection:</b> Integration				<b>Other manufacturer's data</b>			
<b>Software/ firmware version:</b> V1.00				<b>Assigned to PGU type:</b> Integrated interface switch			
<b>Manufacturer:</b> Shenzhen SOFARSOLAR Co., Ltd.							
<b>Measuring period:</b>							
Protection function	Setting value	Tripping value (Vac)			Break time (ms)		
		1 <sup>st</sup>	2 <sup>nd</sup>	3 <sup>rd</sup>	1 <sup>st</sup>	2 <sup>nd</sup>	3 <sup>rd</sup>
Voltage drop protection $U <$	0.77 $U_n$	177.1	177.1	177.1	167.0	161.5	164.5
Voltage drop protection $U <$	0.8 $U_n$	--	--	--	--	--	--
Rise-in-voltage protection $U >$	1.1 $U_n$	--	--	--	507s*		
Rise-in-voltage protection $U >>$	1.15 $U_n$	--	--	--	--	--	--
Rise-in-voltage protection $U >>$	1.18 $U_n$	271.4	271.4	271.4	165.5	153.5	162.0
Frequency decrease protection $f <$	47.5 Hz	47.48	47.48	47.48	154.5	170.5	162.5
Frequency increase protection $f >$	51.5 Hz	51.51	51.51	51.51	134.5	160.5	153.0
Proper time of interface switch		20ms					
<p>The break time (sum of tripping time NS protection plus proper time of interface switch) shall not exceed 200ms.          The verification of the full functional chain "NS protection – Interface switch" has yield to intended disconnection.          * Results of the protection of the Increase in voltage as 10-min moving average</p>							

Appendix 2: System topology

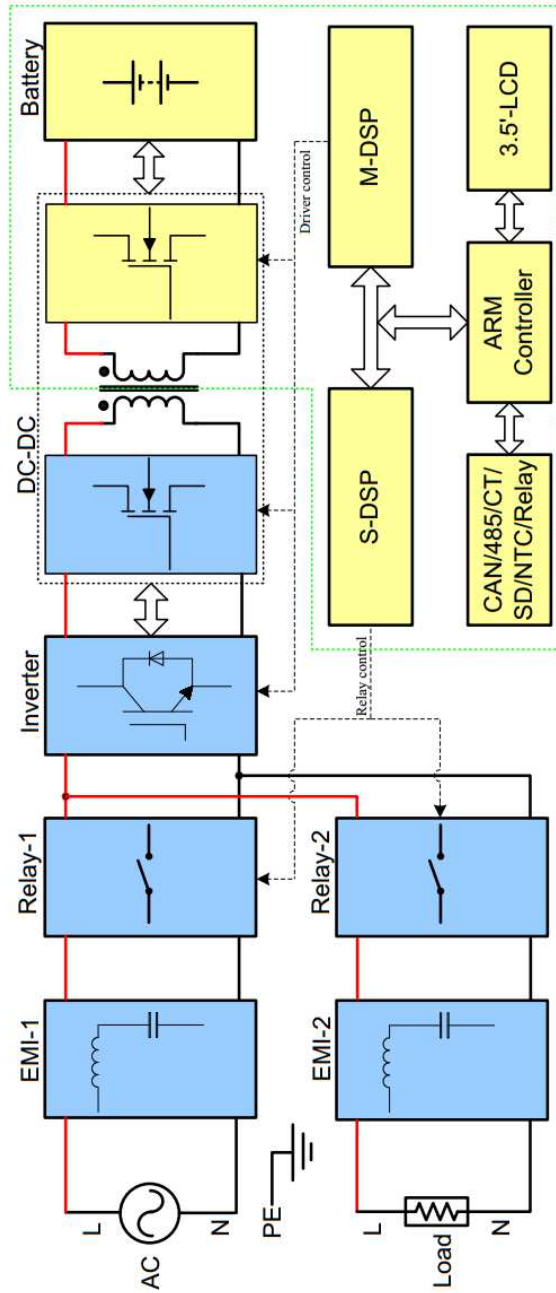

Appendix 2: Photos



Overview



Overview

Appendix 2: Photos



Top view



Heatsink view



Appendix 2: Photos



Terminal view



Terminal view

Appendix 2: Photos



Inside view



Inside view



Appendix 3: Photos

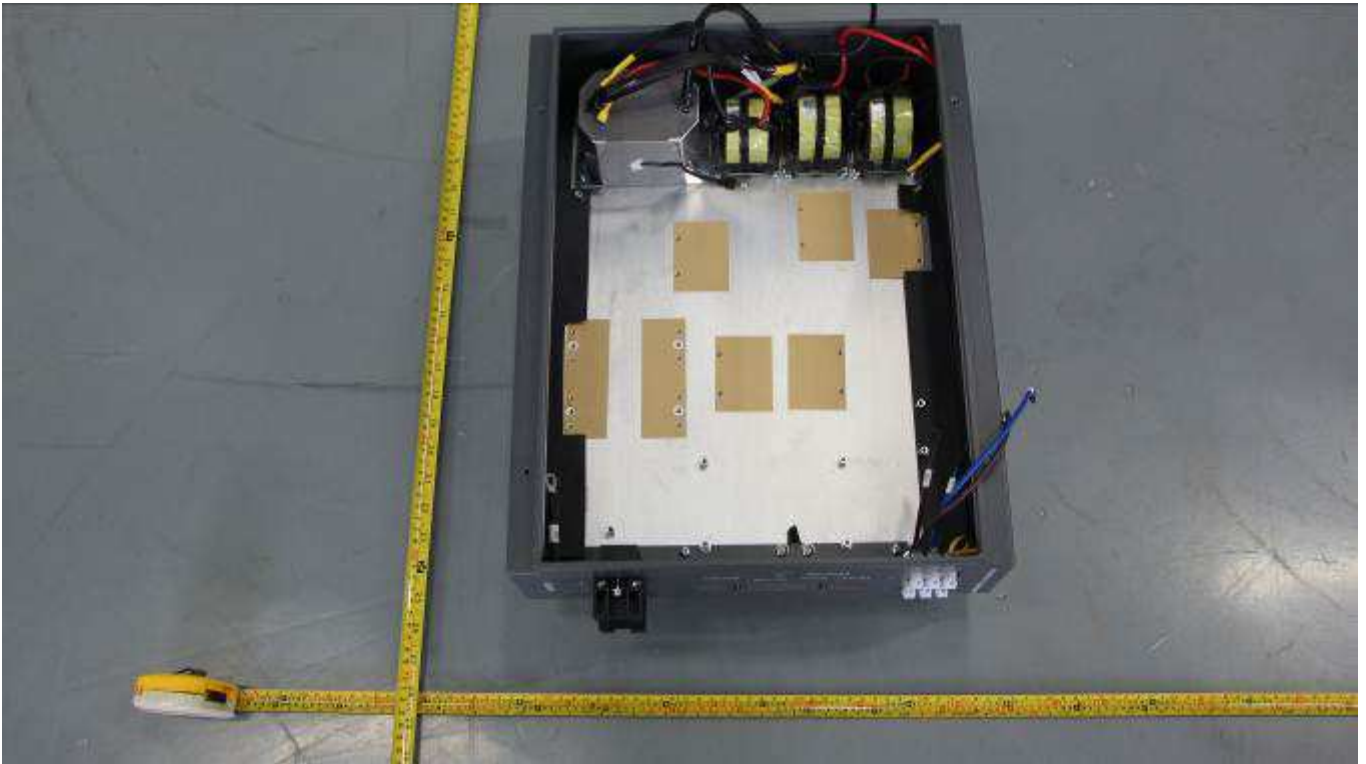

Inside view



Communication board view

Appendix 3: Photos

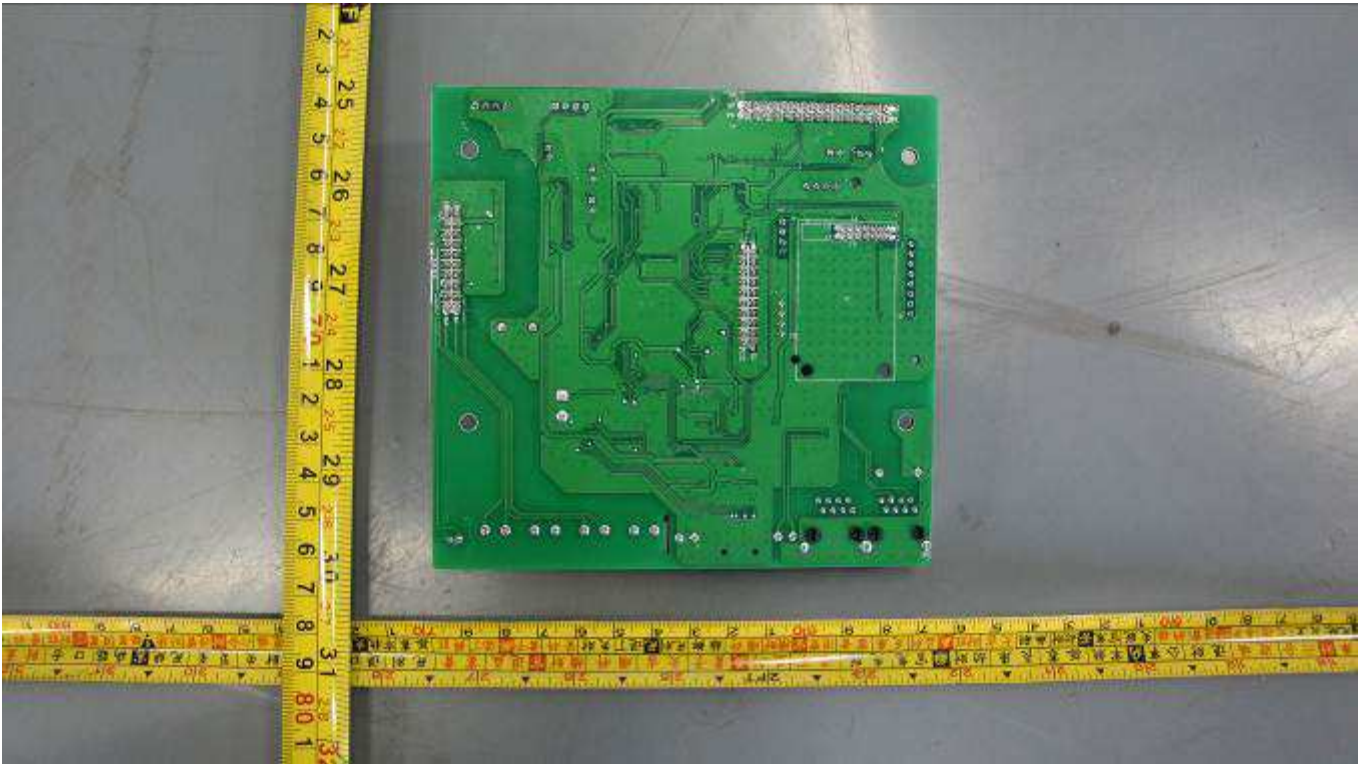

Soldered view

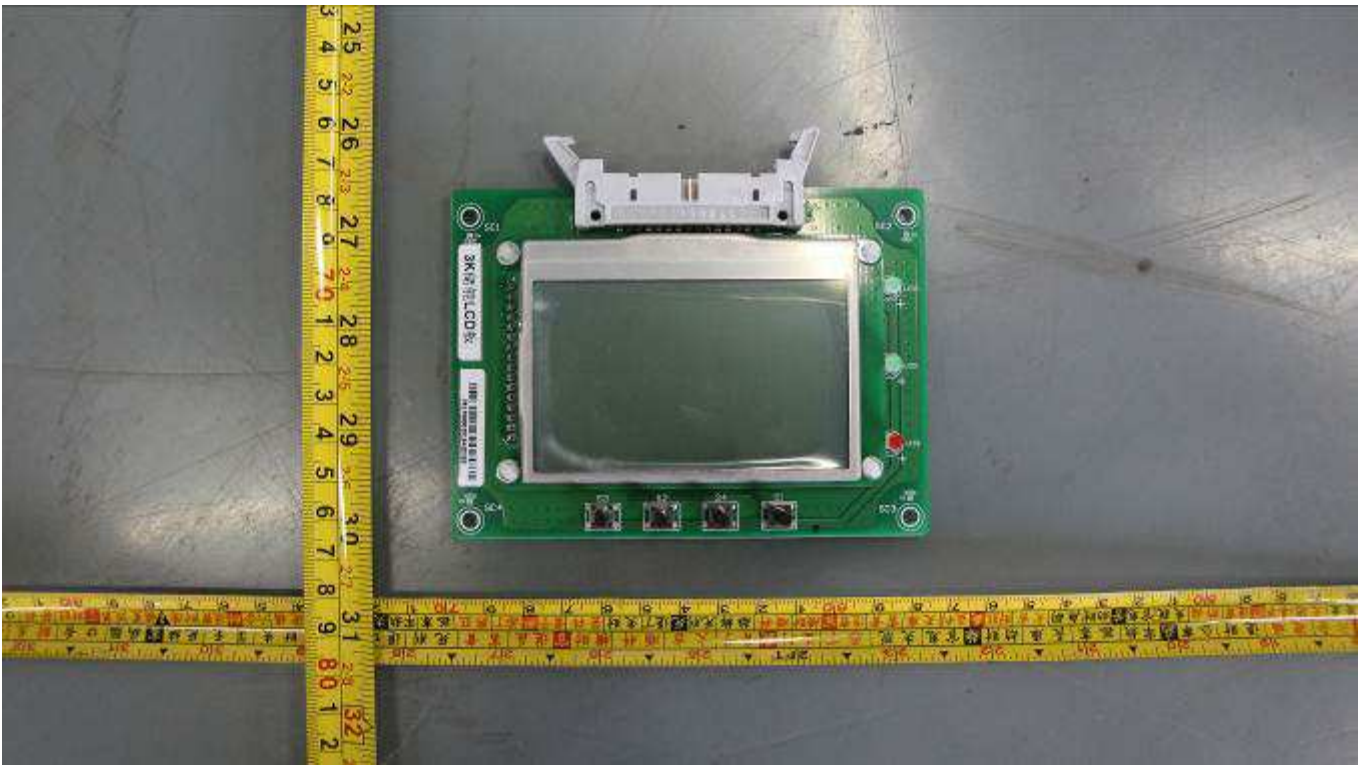

LCD display view



Appendix 3: Photos

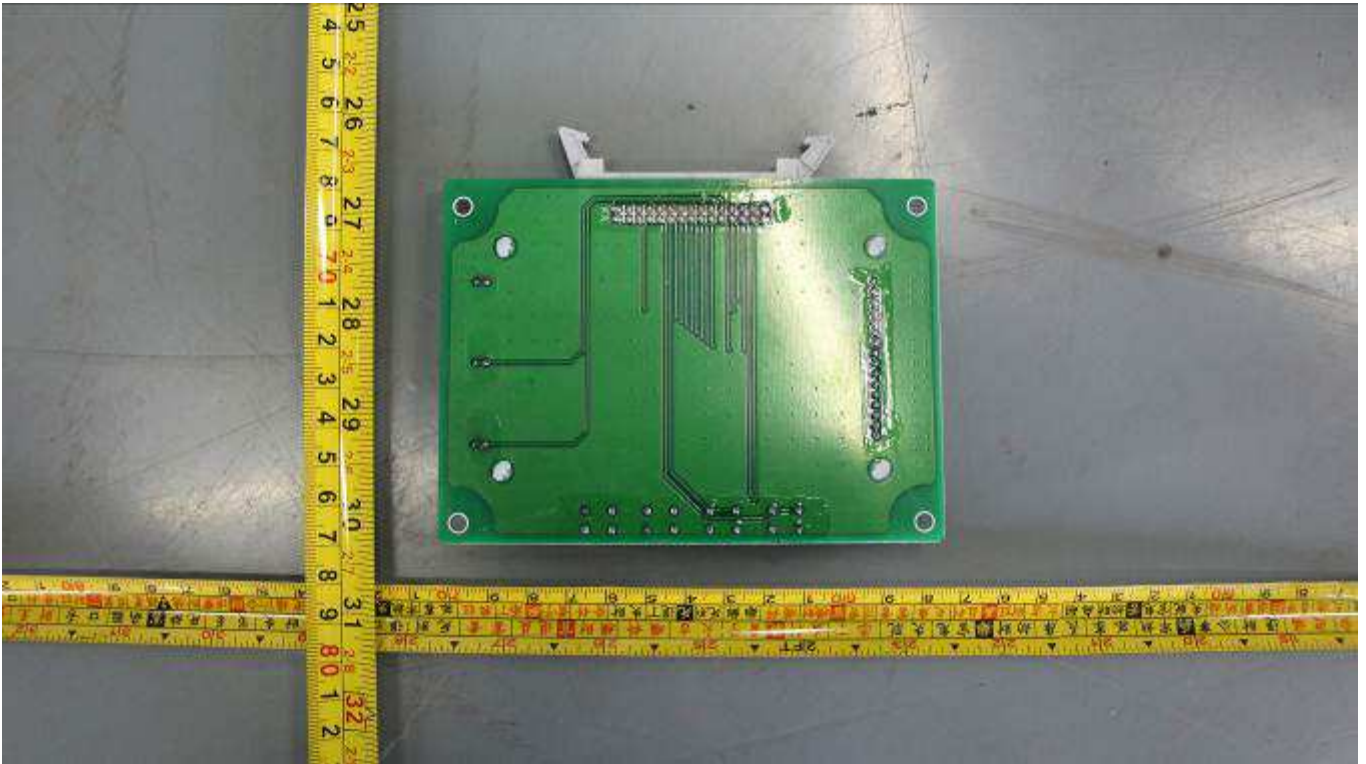

LCD display view

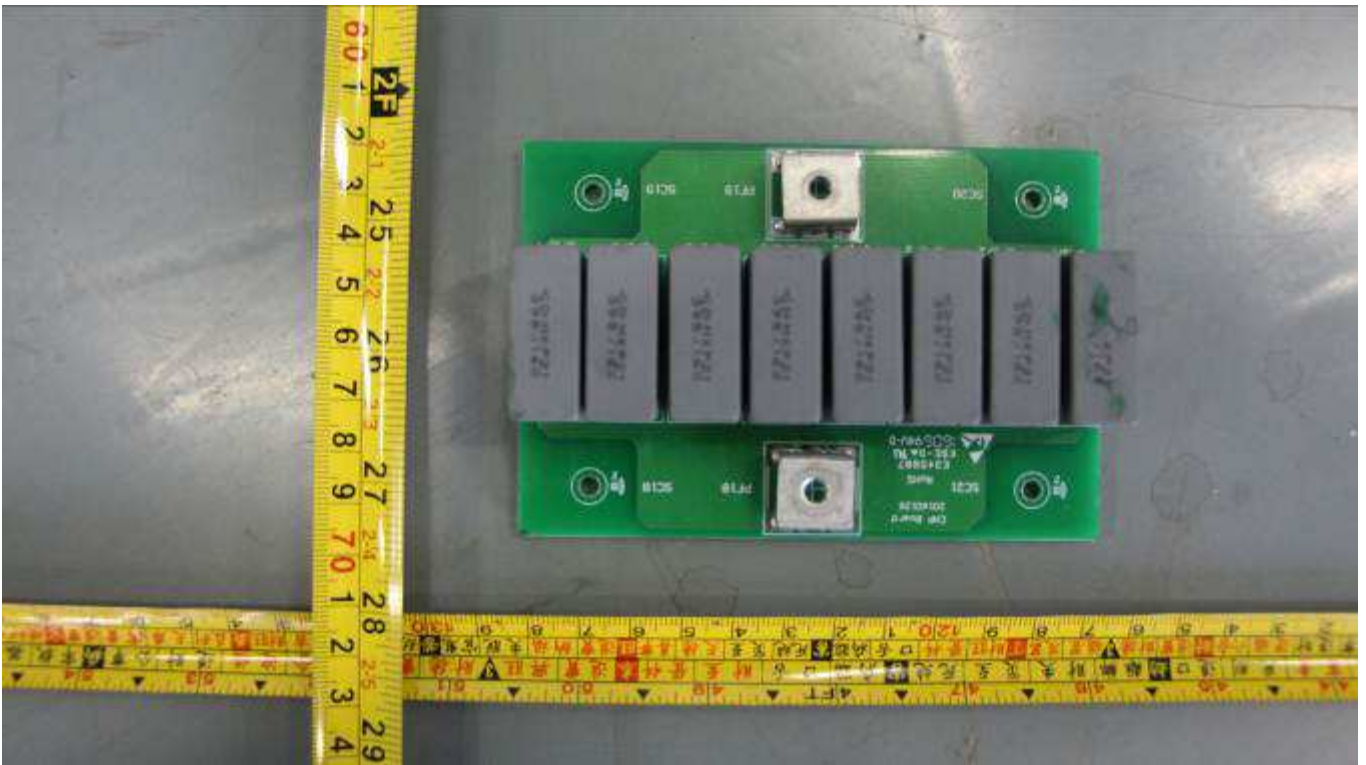

Capacitor A board view

Appendix 3: Photos

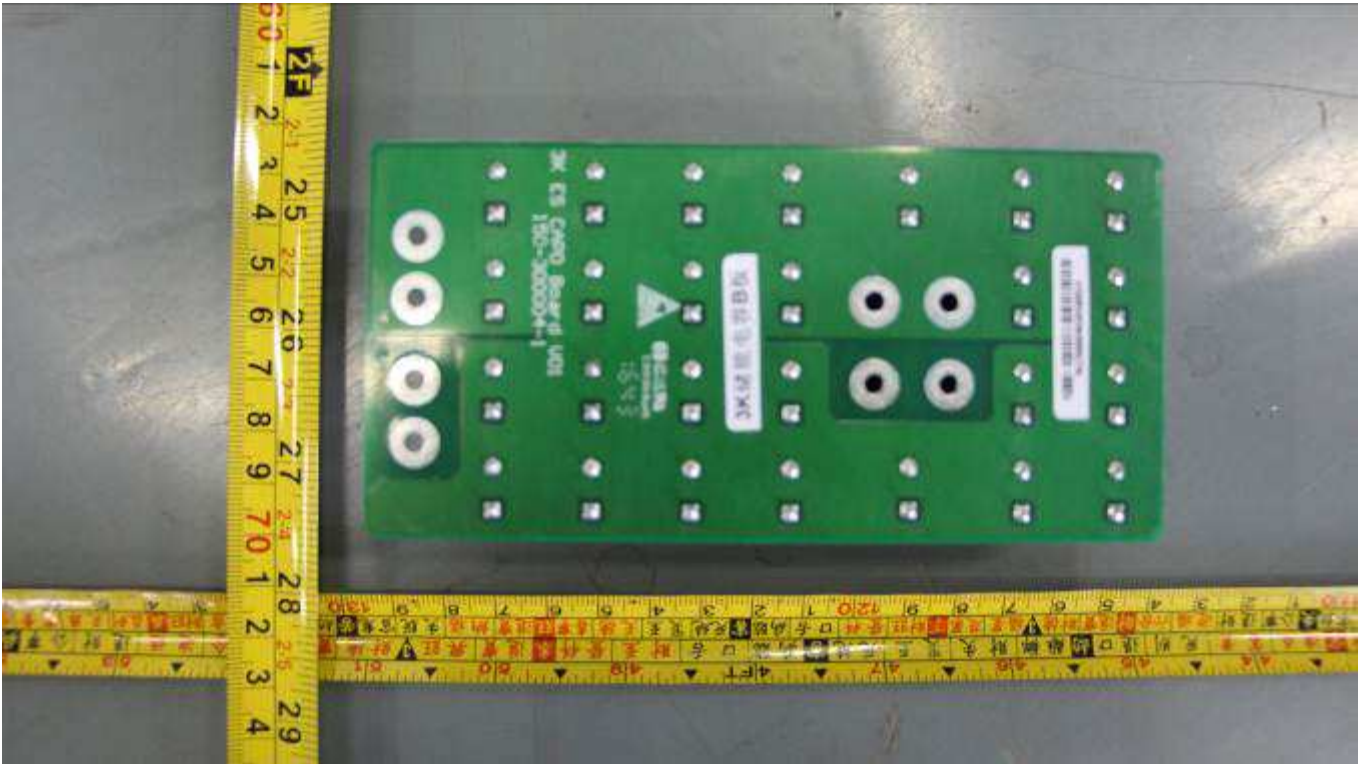

Soldered view



Capacitor B board view



Appendix 3: Photos



Main board view

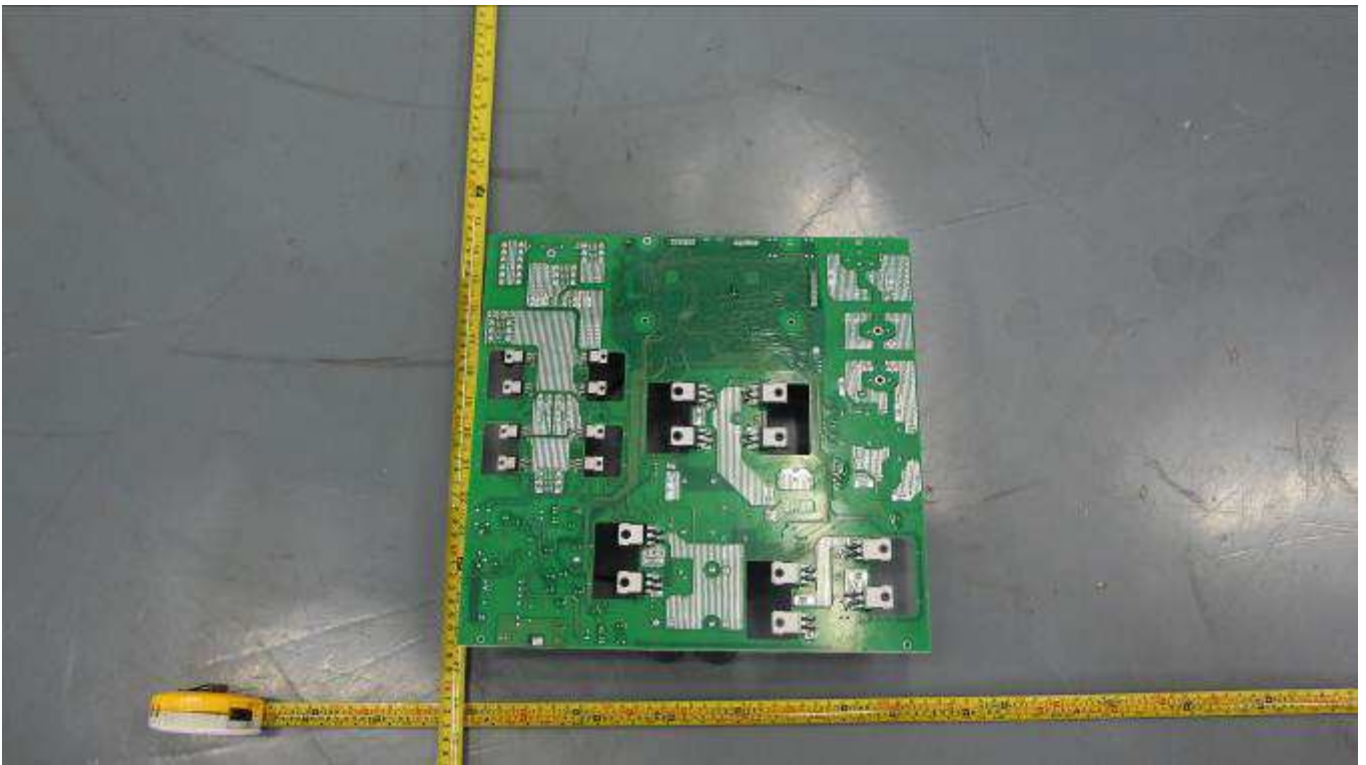

Soldered view

Appendix 4: Equipment lists

<u>Equipment Description:</u>				
<u>Number:</u>	<u>Equipment No.</u>	<u>Name</u>	<u>Brand</u>	<u>Model</u>
01	SA200-01	Power analyzer	YOKOWAWA	WT3000
02	SA200-04	DC Power	--	DCST-800-120
03	SA200-05	AC Power	--	ACST-L-33075
04	SA050-11	Oscillograph	Tektronix	TDS3052
05	SA002-17	Withstand voltage tester	KIKVSUI	T0S5052
06	SA023-08	Earthing resistor tester	OS	CS9950L
07	SA016-13	Programmable temperature and humidity test chamber	--	WGD/SJ-40408
08	SA200-02	RLC Load	--	ACLT-4830H